

SOLO TREE MOUNT (SURFACE MOUNT)

The Solo Tree Mount is a surface mount with many uses beyond lighting. Compact and adjustable, it allows for quick hanging with two supplied Titanium screws (best for tree health) or optional nylon straps. It may be used with any Direct Connect fixtures.

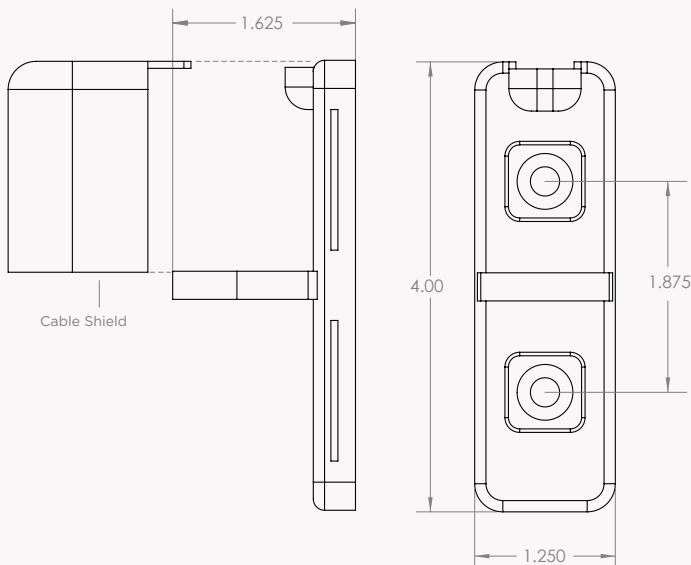

SOLO TREE MOUNT SPECIFICATIONS

Size (L x W x H): 4.0in x 1.25in x 1.625in

Weight: 1.0 lb

Construction: Solid Brass



Finish: Vintage, White, Nickel

Compatibility: MR11, MR16 Bullet, Wash Light

Mounting: 2 x #12 2" Ti screws (included), Hanger Bolts or Tree Straps (sold separately)



Warranty: 5-Year Limited Warranty*

ORDERING INFORMATION

ACCESSORY	FINISH
SMT (SOLO TREE MOUNT)	VB (VINTAGE BRASS) 
	WT (WHITE) 
	NI (NICKEL) 

SMT — **VB** e.g. **SMTVB** = Vintage Brass Solo Tree Mount

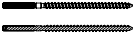
COMPATIBLE PRODUCTS

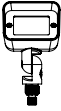
SKU	ITEM	
TS48BN	Tree Straps	
HBOLT	Hanger Bolts	
BT11xx	MR11 Bullet Light - Direct Connect	
WLxxxxxx	Wash Light	

*Lifetime Warranty for certified installations. See terms and conditions of sale for details.