

FLUSH MOUNT w/ ESCUTCHEON 1/2"

The Flush Mount w/ Escutcheon features a very clever, threaded cover plate that covers the mounting screws for the type of clean installation customers deserve--but haven't seen before. Works on ceilings, pergolas and other flat surfaces and is the best flush mount on the market.

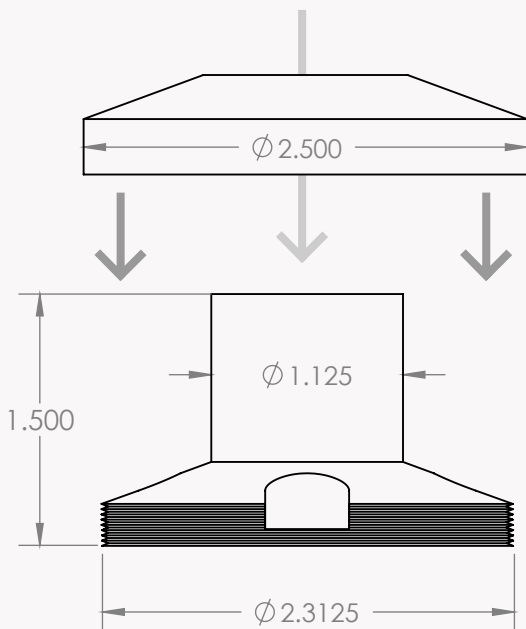

FLUSH MOUNT SPECIFICATIONS

Size: 1.5in (H) x 2.5in (ϕ)

Weight: 0.5 lbs

Construction: Solid Brass

Finish: Vintage, White, Nickel

Threading: 1/2" NPSM



Compatibility: MR11, MR16 Bullet, Wash Light

Mounting: Screws (sold separately)

Warranty: 5-Year Limited Warranty*

No screws provided (recommend #12 screws in brass or stainless) - length to be chosen by installer based on mounting substrate

ORDERING INFORMATION

FIXTURE	SIZE	FINISH
FM (FLUSH MOUNT W/ ESCUTCHEON)	1/2 (½" NPSM)	VB (VINTAGE BRASS) 
		WT (WHITE) 
		NI (NICKEL) 

FM — **1/2** — **VB** e.g. **FM1/2VB** = Vintage Brass ½" Flush Mount Escutcheon

COMPATIBLE PRODUCTS

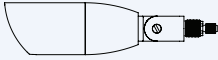
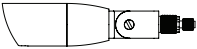
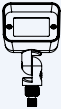
SKU	ITEM	
BT16xx	MR16 Bullet Light - Direct Connect	
BT11xx	MR11 Bullet Light - Direct Connect	
WLxxxxxx	Wash Light	
SPK8M6K4SS	Stainless Steel Spikes	

*Lifetime Warranty for certified installations. See terms and conditions of sale for details.